

# CATALOGO

2020

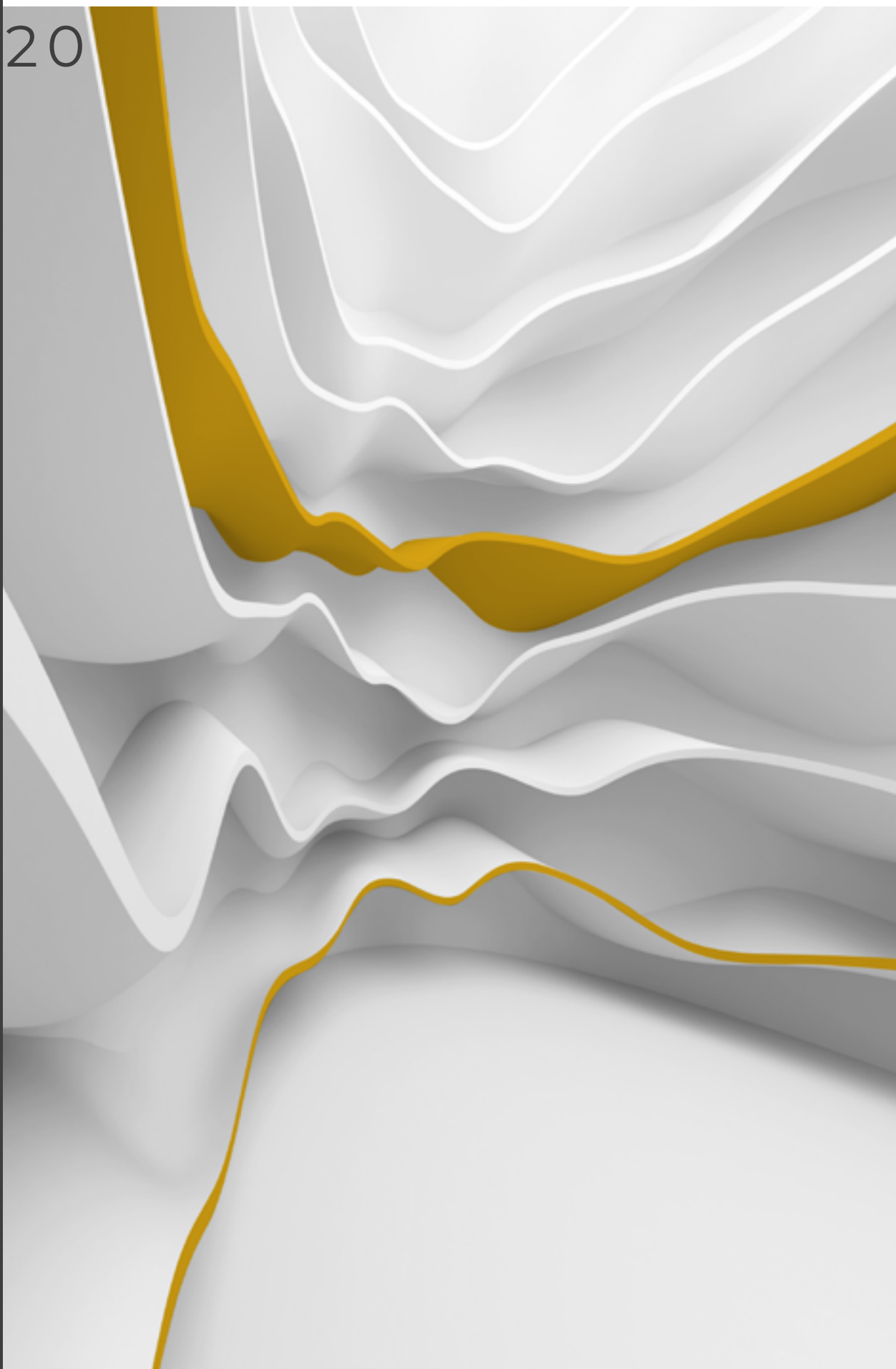

# CUCINE STARON®

LINEA WHITE | DA INCASSO

## B3290

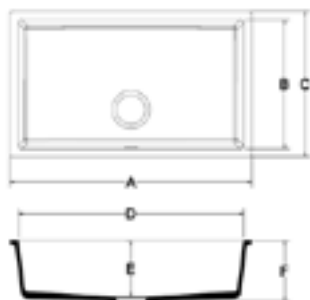

BTQDAA00066	MISURE
A	750mm
B	400mm
C	450mm
D	700mm
E	177mm
F	200mm

\*Bordo sporgente



Articolo da abbinare a lastre Staron Bright White  
**Lavabi senza troppopieno**

## B3180

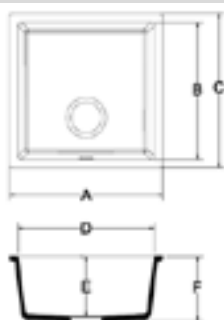

BTQDAA00051	MISURE
A	450mm
B	400mm
C	450mm
D	400mm
E	177mm
F	190mm



Articolo da abbinare a lastre Staron Bright White  
**Lavabi senza troppopieno**

## KA1181

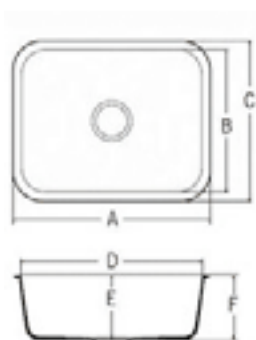

BTQDAA00006	MISURE
A	460mm
B	400mm
C	460mm
D	400mm
E	208mm
F	225mm

\*Bordo sporgente



Articolo da abbinare a lastre Staron Bright White  
**Lavelli senza troppopieno**

# CUCINE STARON®

LINEA WHITE | DA INCASSO

## A1121

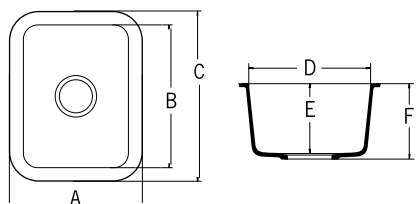

BTQDAA00001	MISURE
A	326mm
B	356mm
C	416mm
D	396mm
E	165mm
F	180mm
Esterno	326/416/180mm



Articolo da abbinare a lastre Staron Bright White  
**Lavelli senza troppopieno**

## A1231

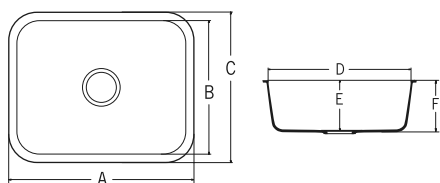

BTQDAA00011	MISURE
A	592mm
B	422mm
C	482mm
D	532mm
E	187mm
F	202mm
Esterno	592/482/225mm



Articolo da abbinare a lastre Staron Bright White  
**Lavelli senza troppopieno**

## A2311

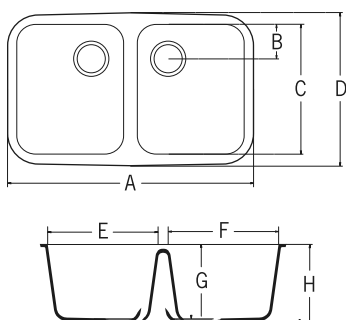

BTQDAA00016	MISURE
A	794mm
B	110mm
C	421mm
D	481mm
E	348mm
F	348mm
G	235mm
H	250mm
Esterno	794/481/250mm



Articolo da abbinare a lastre Staron Bright White  
**Lavelli senza troppopieno**

# CUCINE STARON®

LINEA WHITE | DA INCASSO

## KGCTK 0151

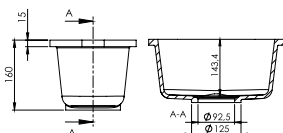

MISURE	L/B/H/RC
Esterno	197/342/160 mm
Interno	151/296/143/23*mm

\*Bordo sporgente

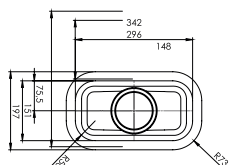

Articolo da abbinare a lastre Staron Bright White  
**Lavelli senza troppopieno**



## KGCTK 0396

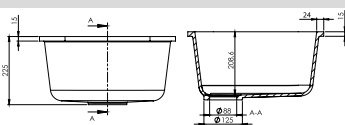

MISURE	L/B/H/RC
Esterno	457/457/225 mm
Interno	396/396/210/24*mm

\*Bordo sporgente

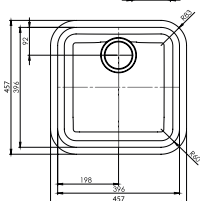

Articolo da abbinare a lastre Staron Bright White  
**Lavelli senza troppopieno**



# LAVELLI PER CUCINA STARON®

## LINEA PREMIUM

### LINEA TONDO DA INCASSO

Spessore lastra 12 mm + bordo rinforzato 3 mm

MODELLO	DIMENSIONI mm
KTK0199	∅ 199 x H 117
KTK0380	∅ 380 x H 167

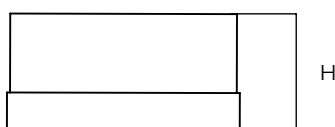
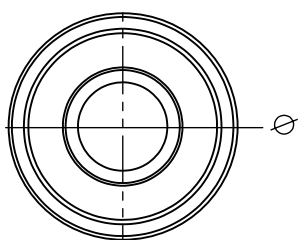

### LINEA RETTANGOLARE CON SPIGOLI TONDI DA INCASSO

Spessore lastra 12 mm + bordo rinforzato 3 mm

MODELLO	DIMENSIONI mm
KCTK0162	L162 x B300 x H122
KCTK0162-352	L162 x B352 x H122
KCTK0240	L240 x B350 x H122
KCTK0332	L332 x B418 x H172
KCTK0375	L375 x B420 x H172
KCTK0400	L400 x B400 x H172
KCTK0450	L450 x B400 x H172
KCTK0495	L495 x B345 x H172
KCTK0500	L500 x B412 x H192
KCTK0550	L550 x B480 x H246

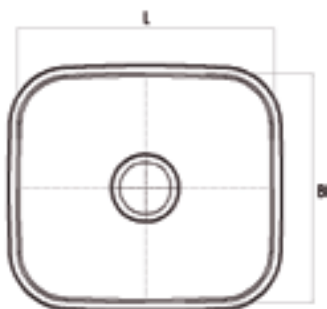

# LAVELLI PER CUCINA STARON®

## LINEA PREMIUM

### LINEA RETTANGOLARE DA INCASSO

Spessore lastra 12 mm + bordo rinforzato 3 mm

MODELLO	DIMENSIONI mm
KDTK0162	L162 x B300 x H187
KDTK0168	L168 x B352 x H187
KDTK0332	L332 x B418 x H187
KDTK0375	L375 x B420 x H187
KDTK0400	L400 x B400 x H187
KDTK0450	L450 x B400 x H187
KDTK0495	L495 x B345 x H187
KDTK0500	L500 x B412 x H187
KDTK0513	L513 x B418 x H217
KDTK0550	L550 x B480 x H237
KDTK0800	L800 x B400 x H237



TUTTI I LAVELLI PER CUCINA DELLA LINEA PREMIUM SONO DISPONIBILI ANCHE CON FONDO IN DIVERSI MATERIALI E TAPPO COPRI-SCARICO IN STARON SOLID SURFACE

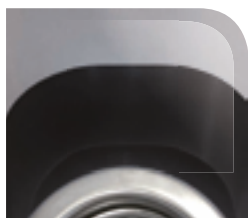

VETRO-CERAMICA



SOLID SURFACE

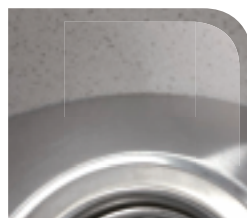

ACCIAIO



COPRITAPPO IN STARON

## NOTE

Tutti i lavabi per bagno della Linea Premium vengono forniti con piletta e sifone "Viega" e sono disponibili con o senza troppopieno. La linea è ordinabile anche con copritappo in Staron.

# BAGNI STARON®

LINEA WHITE | DA INCASSO

## B3190

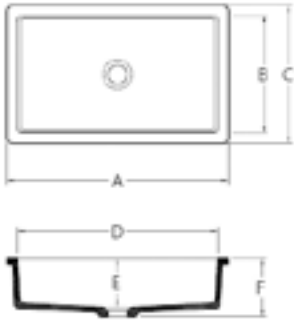

BTQDAA00087	MISURE
A	524mm
B	279mm
C	324mm
D	474mm
E	116mm
F	138mm

\*Bordo sporgente



NEW!

Articolo da abbinare a lastre Staron Bright White  
**Lavabi con troppopieno (senza troppopieno BTQDAA00082)**

## B3150

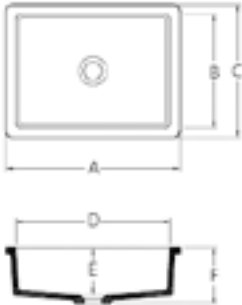

BTQDAA00094	MISURE
A	428mm
B	278mm
C	328mm
D	378mm
E	116mm
F	138mm

\*Bordo sporgente



NEW!

Articolo da abbinare a lastre Staron Bright White  
**Lavabi con troppopieno (senza troppopieno BTQDDA00081)**

## B3211

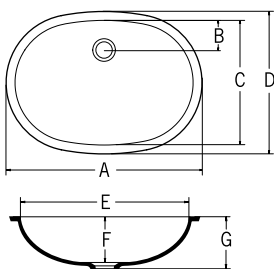

BTQDAA00037	MISURE
A	548mm
B	66mm
C	356mm
D	396mm
E	508mm
F	156mm
G	173mm



Articolo abbinabile esclusivamente a lastre Staron Bright White  
**Lavabi bagno senza troppopieno**

# BAGNI STARON®

LINEA WHITE | DA INCASSO

## B3181

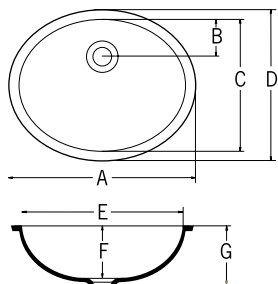

BTQDAA00040	MISURE
A	462mm
B	94mm
C	336mm
D	376mm
E	422mm
F	139mm
G	156mm



Articolo abbinabile esclusivamente a lastre Staron Bright White

**Lavabi bagno con troppopieno (senza troppopieno cod. BTQDAA00021)**

## BGTR 0350

## BGTR 0370

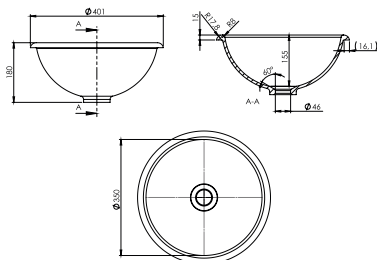

BGTR 0350	MISURE
Esterno	365/180/mm
Interno	350/150/23*mm

BGTR 0370	MISURE
Esterno	395/
Interno	370/146mm

\*Bordo sporgente



Articolo da abbinare a lastre Staron Bright White

**Lavabi senza troppopieno**

## BGTE 0505

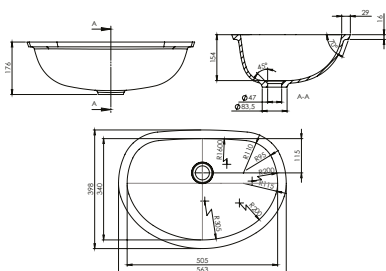

	MISURE
Esterno	563/398/176 mm
Interno	505/340/154/29*mm

\*Bordo sporgente



Articolo da abbinare a lastre Staron Bright White

**Lavabi senza troppopieno**



# BAGNI STARON®

## LINEA WHITE | DA APPOGGIO

### BGTE 0370

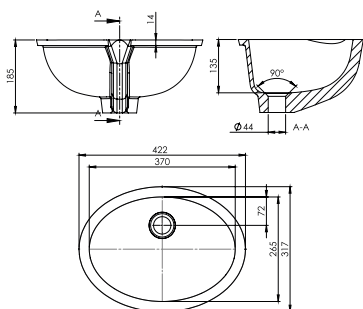

	MISURE
Esterno	422/317/185mm
Interno	370/265/135/26*mm

\*Bordo sporgente



Articolo da abbinare a lastre Staron Bright White  
**Lavabi senza troppopieno**

### BGTE 0415

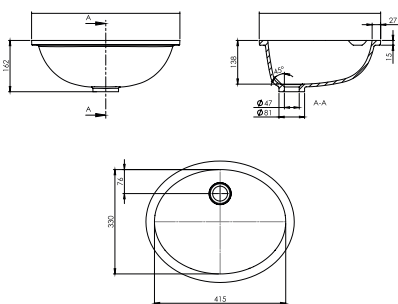

	MISURE
Esterno	450/350/163mm
Interno	415/330/138 /26*mm

\*Bordo sporgente



Articolo da abbinare a lastre Staron Bright White  
**Lavabi senza troppopieno**

### BGTE 0504

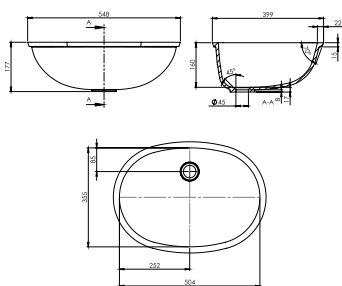

	MISURE
Esterno	548/385/177mm
Interno	504/355/160/22*mm

\*Bordo sporgente



Articolo da abbinare a lastre Staron Bright White  
**Lavabi senza troppopieno**

# BAGNI STARON®

LINEA WHITE | DA INCASSO

## BGTL 0560

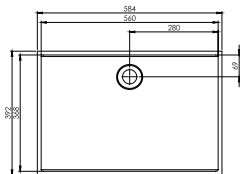
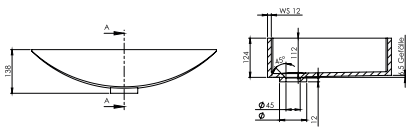

	MISURE
Esterno	584/392/138mm
Interno	560/368/124mm

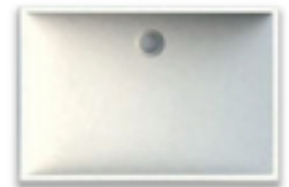

Articolo da abbinare a lastre Staron Bright White  
**Lavabi senza troppopieno**

# LAVABI PER BAGNI STARON®

## LINEA PREMIUM

### LINEA TONDO DA INCASSO

Spessore lastra 12 mm

MODELLO	DIMENSIONI mm
BTR0250	∅ 250 x H 124
BTR0325	∅ 325 x H 133
BTR0374	∅ 368 x H 154
BTR0375	∅ 375 x H 142
BTR0400	∅ 400 x H 159
BTR0445	∅ 445 x H 155

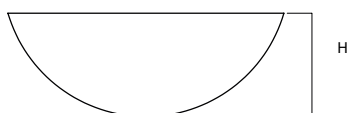
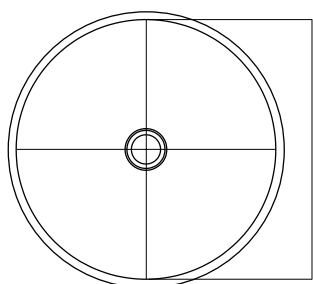

### LINEA OVALE DA INCASSO

Spessore lastra 12 mm

MODELLO	DIMENSIONI mm
BTE0360	L360 x B260 x H134
BTE0415	L415 x B304 x H134
BTE0420	L420 x B336 x H150
BTE0465	L465 x B346 x H144
BTE0470	L470 x B336 x H135
BTE0520	L520 x B372 x H142
BTE0540	L525 x B397 x H155
BTE0562	L540 x B361 x H135
BTE0653	L562 x B382 x H134
BTE0656	L656 x B380 x H125

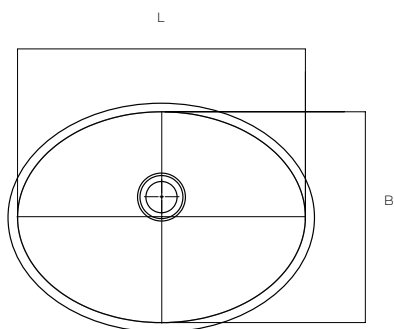

# LAVABI PER BAGNI STARON®

## LINEA PREMIUM

### LINEA RETTANGOLARE DA INCASSO

Spessore lastra 12 mm

MODELLO	DIMENSIONI mm
BTL0400	L400 x B300 x H145
BTL0460-028	L460 x B280 x H145
BTL0460-038	L460 x B380 x H148
BTL0560	L560 x B368 x H133
BTL0800	L800 x B356 x H133
BTL1100	L1100 x B368 x H137

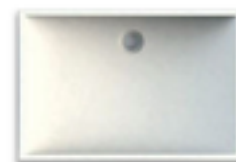
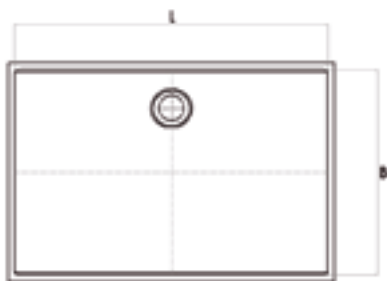

### LINEA RETTANGOLARE DA APPOGGIO

Spessore lastra 12 mm

MODELLO	DIMENSIONI mm
BATL0560	L560 x B360 x H150
BATL1100	L1100 x B368 x H150

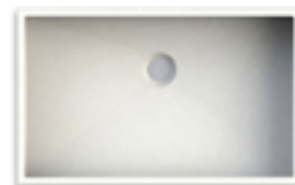
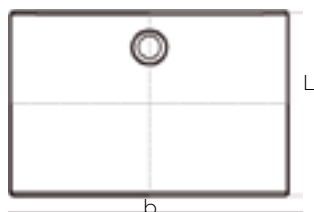

# LAVABI PER BAGNI STARON®

## LINEA PREMIUM

### LINEA RETTANGOLARE DA INCASSO - INTERNO SFACCETTATO

Spessore lastra 12 mm

MODELLO	DIMENSIONI mm
BTP0400	L400 x B260 x H94
BTP0500	L500 x B300 x H94
BTP0550	L550 x B370 x H97
BTP0700	L700 x B370 x H97
BTP0800	L800 x B370 x H97
BTP0900	L900 x B370 x H97
BTP1100	L1100 x B370 x H97

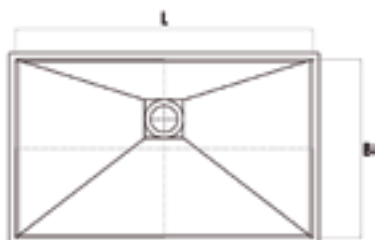

### LINEA RETTANGOLARE DA APPOGGIO - INTERNO SFACCETTATO

Spessore lastra 12 mm

MODELLO	DIMENSIONI mm
BATP0400	L400 x B260 x H120
BATP0500	L500 x B300 x H120
BATP0550	L550 x B370 x H120
BATP0700	L700 x B370 x H120
BATP0800	L800 x B370 x H120
BATP0900	L900 x B370 x H120
BATP1100	L1100 x B370 x H120

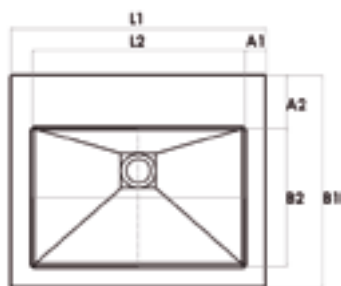

## NOTE

Tutti i lavabi per bagno della Linea Premium vengono forniti con piletta e sifone "Viega" e sono disponibili con o senza troppopieno. La linea è ordinabile anche con copritappo in Staron.

# VASCHE DA BAGNO STARON®

## LINEA WHITE

### VGTB 0675 Vasca per neonati

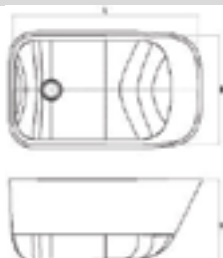

	MISURE
Esterno	695/380/335mm
Interno	675/400/315mm



Articolo abbinabile esclusivamente a lastre Staron Bright White

### VGTB 0670 Vasca per neonati

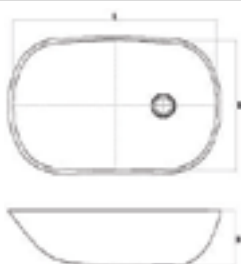

	MISURE
Esterno	693/353/190mm
Interno	670/428/170mm



Articolo abbinabile esclusivamente a lastre Staron Bright White

### VBT1750

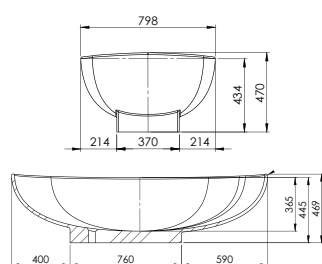

	MISURE
Esterno	1750/798/470 mm
Interno	1707/756/434mm

\*Bordo sporgente



Articolo abbinabile esclusivamente a lastre Staron Bright White

### VBT1865

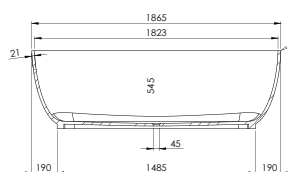



	MISURE
Esterno	1865/895/585mm
Interno	1823/853/545mm

\*Bordo sporgente



Articolo abbinabile esclusivamente a lastre Staron Bright White

# ACCESSORI STARON®

	ARTICOLO	CODICE
	Nastro ceramico Kaowool 1 lato adesivo	8C14107
	Piletta basket	1745.044
	Sifoni salva spazio Per lavelli a una o due vasche	/
	Dispenser manuale Capacità 250 ml	DM200-10
	Mixer 250 ml Punte di ricambio	CMFHX08-18T-100
	Dispenser manuale Capacità 50 ml	DS51-10-00
	Mixer 50 ml Punte di ricambio	MBHX05-16T-100

Per conoscere modelli e prezzi delle pilette e dei sifoni contattare l'Ucio Commerciale

staron<sup>®</sup> | Solid  
Surfaces

*FPS S.r.l*

Via Bologna 1H, 20060 Trezzano Rosa (MI)

Tel. +39 02 9200551 | [staron@staronitalia.it](mailto:staron@staronitalia.it)

[www.staronitalia.it](http://www.staronitalia.it)

Distributore unico per l'Italia Staron Solid Surface

